

SPECIFICATIONS

Dimensions:	206 x 67 cm	Motor force:	8 kN
Weight:	87 kg	Motor usage:	Max. 2 minutes/ 18 minutes off
Height adjustment:	± 47 – 97 cm	Hydraulic pump:	10 kN
Lifting capacity:	Max. 200 kg	Frame material:	Steel frames
Mains voltage:	100 - 240 VAC, 50 - 60 Hz	Frame finish:	Powder coated white RAL 9016
Current:	Max. 3.0 A	Conformity:	IEC/EN 60601-1:2013 ed. 3.1 IEC/EN 60601-2: 2015 ed. 4.0 93/42/EEC WEEE RoHS2
Standby power consumption:	Max. 3 W	Warranty:	Table 3 years, Premium upholstery 3 years, Classique upholstery 1 year
Insulation:	Class II		
Device Classification	I		
Applied parts	Type BF		
Humidity proof:	IP22		

FUNCTIONALITY/ DIMENSIONS

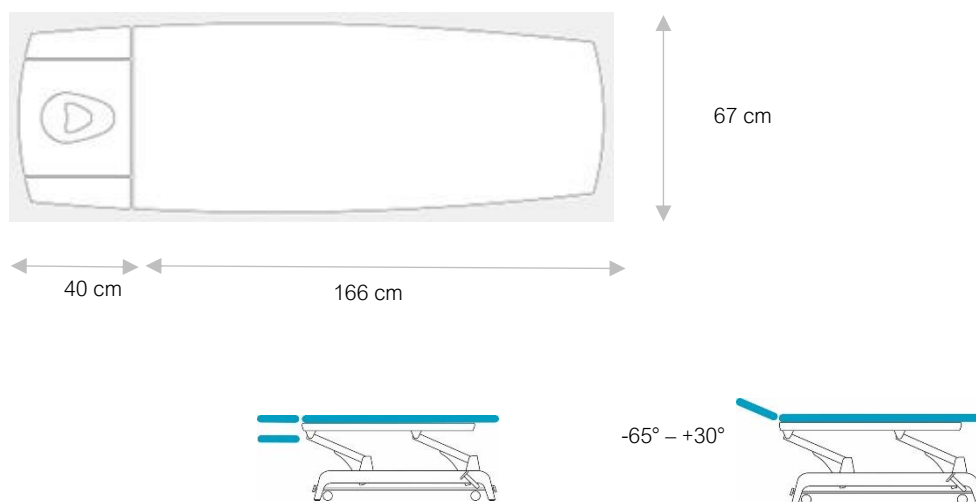

CUSHIONS UPHOLSTERY

Classique:	PVC, phthalate free, biocompatible, abrasion resistant and flame retardant.
Premium:	PU, phthalate free, biocompatible, abrasion resistant and flame retardant.

CUSHIONS FINISH

Linear:	Single padded, 40 kg/m ³
Progressive:	Dual padded, 100 kg/m ³ and 40 kg/m ³

OPTIONS

Ergomax:	PU foam, closed skin, low density 5° Shore	Memory function:	Three programmable settings for height adjustment Bluetooth wireless operation
Cushion heating:	34 °C, 36 °C and 38 °C Bluetooth wireless operation	LED Pack:	Chassis illumination 14 colours, including brightness control Power consumption = 10 W
Battery function:	Automatic timer 30 minutes Maximum consumption = 180 W Li-ion 25,9 VDC, 2,25 Ah	Safe Motion Detection:	Power consumption = 1 W